

## ISO B

ACCIAIO  
STEEL  
STAHL  
ACIER

### Caratteristiche tecniche I

- Norma: ISO 7241 B
- Occlusione: valvola
- Aggancio: sfere radiali
- Materiale: acciaio
- Finitura: Zn-Fe (Cr III)
- Filettature: BSP - NPT- SAE
- Guarnizioni standard: NBR
- Temperatura d'esercizio: -25 °C +100 °C
- Guarnizioni opzionali: FKM, FFKM, EPDM o altro
- Pressioni di esercizio: 100-500 bar
- Connessione in pressione: non consentita

### Technical data E

- Standard: ISO 7241 B
- Occlusion: poppet
- Locking: radial balls
- Material: steel
- Finishing: Zn-Fe (Cr III)
- Threads: BSP - NPT- SAE
- Standard seals: NBR
- Working temperature: -25 °C +100 °C
- Optional seals: FKM, FFKM, EPDM or more
- Working pressure: 100-500 bar
- Connection under pressure: not allowed

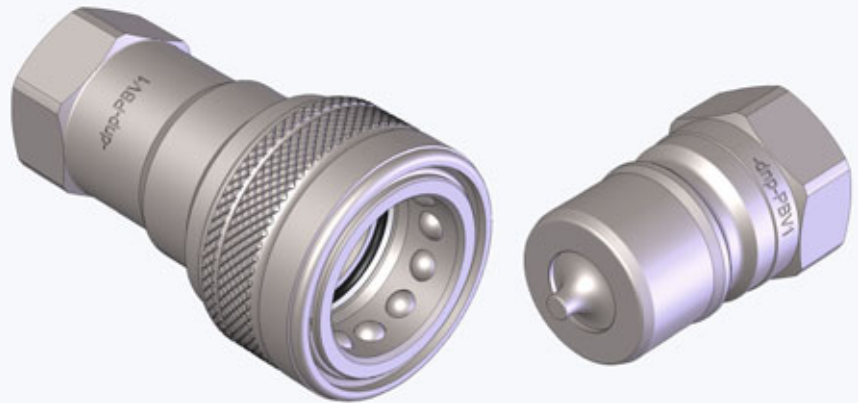

Nominal size				Max working pressure	Rated flow	Max flow rate	Min burst pressure			Fluid spillage
							Male	Female	Coupled	
DNP	BG	ISO	mm	MPa	l/min	l/min	MPa	MPa	MPa	cc
04	0	5	4.2	50	3	9	240	230	270	0.5
06	1	6.3	6.5	25	12	24	110	180	100	1
10	2	10	8.5	25	23	46	140	140	130	2.4
13	3	12.5	10.5	25	45	90	110	140	110	3.9
20	4	20	15.8	25	106	220	100	130	120	11
25	5	25	17.3	25	189	260	100	110	100	19
39	7	40	36	20	379	757	80	80	80	95
50	8	50	50	10	757	1000	40	40	40	170

1 MPa = 145.04 psi • 1 l = 0.264 gal

### Technische Merkmale D

- Norm: ISO 7241 B
- Verschluss: ventil
- Kupplung: Radial Kugeln
- Werkstoff: Stahl
- Ausführung: Zn-Fe (Cr III)
- Gewinde: BSP - NPT- SAE
- Standard-Dichtungen: NBR
- Betriebstemperatur: -25 °C +100 °C
- Dichtungen nach Wahl: FKM, FFKM, EPDM, usw.
- Betriebsdruck: 100-500 bar
- Kuppeln unter Druck: nicht möglich

### Caracteristiques techniques F

- Norme: ISO 7241 B
- Obturation: clapet
- Accrochage: billes radiales
- Matériel: acier
- Traitement: Zn-Fe (Cr III)
- Taraudage: BSP - NPT- SAE
- Joints standard: NBR
- Température de service: -25 °C +100 °C
- Joints facultatifs: FKM, FFKM, EPDM, ect.
- Pression de service: 100-500 bar
- Connexion sous pression: pas possible

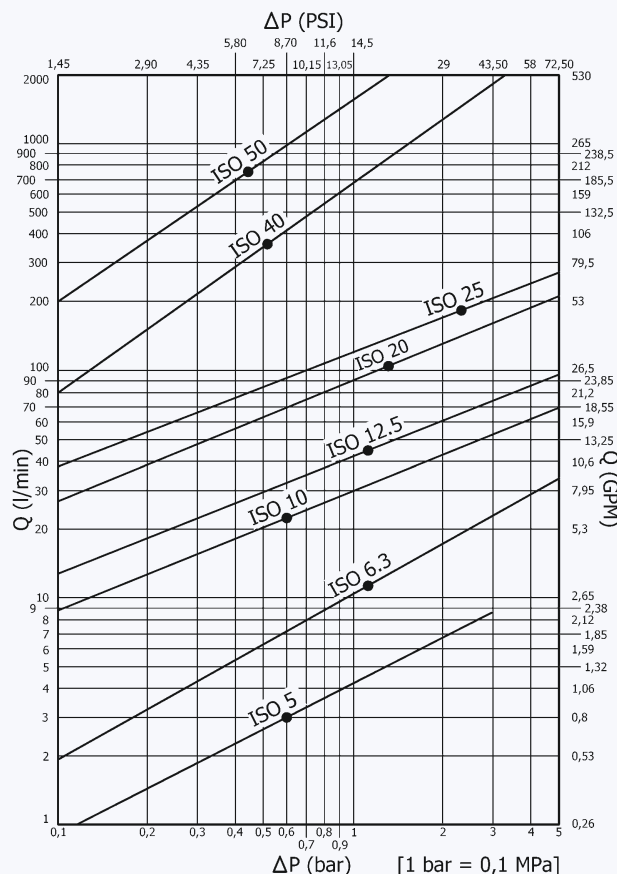

**PBV1 DN04 - BG 0 - ISO 5**

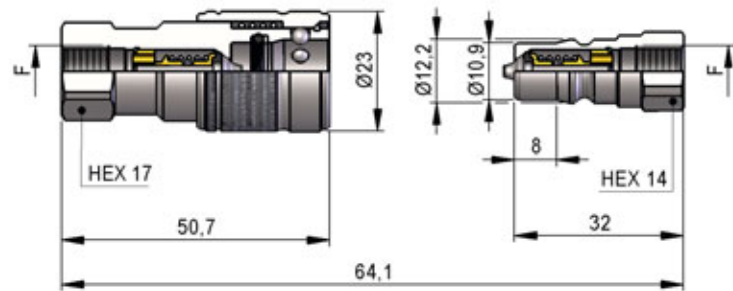

F	STANDARD	FEMMINA - FEMALE - MUFFE - FEMELLE			MASCHIO - MALE - STECKER - MALE		
		COD. F	Weight (g)	Packaging (pcs.)	COD. M	Weight (g)	Packaging (pcs.)
BSP 1/8"	DIN 3852-2-X	PBV1.0404.002	89	160	PBV1.0404.003	20	500
NPT 1/8"	ANSI B1.20.3	PBV1.0404.012	89	160	PBV1.0404.013	20	500

**PBV1 DN06 - BG 1 - ISO 6.3**

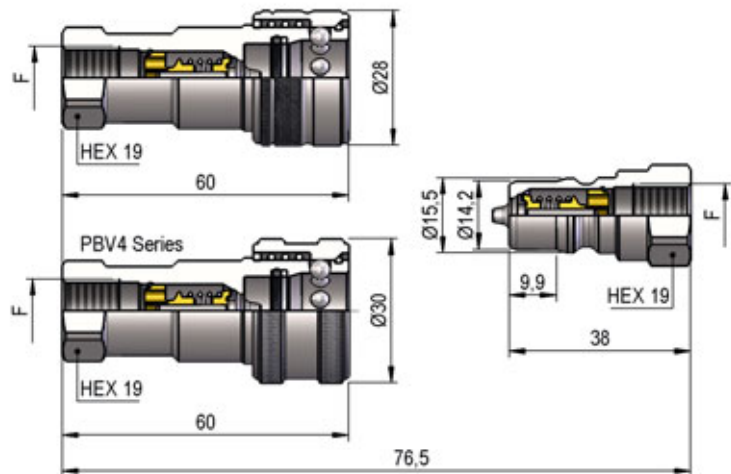

F	STANDARD	FEMMINA - FEMALE - MUFFE - FEMELLE			MASCHIO - MALE - STECKER - MALE		
		COD. F	Weight (g)	Packaging (pcs.)	COD. M	Weight (g)	Packaging (pcs.)
BSP 1/4"	DIN 3852-2-X	PBV1.0606.002	123	100	PBV1.0606.003	39	300
NPT 1/4"	ANSI B1.20.3	PBV1.0606.012	124	100	PBV1.0606.013	40	300
BSP 1/4"	DIN 3852-2-X	PBV4.0606.002	133	80			
NPT 1/4"	ANSI B1.20.3	PBV4.0606.012	134	80			

## PBV1 DN10 - BG 2 - ISO 10

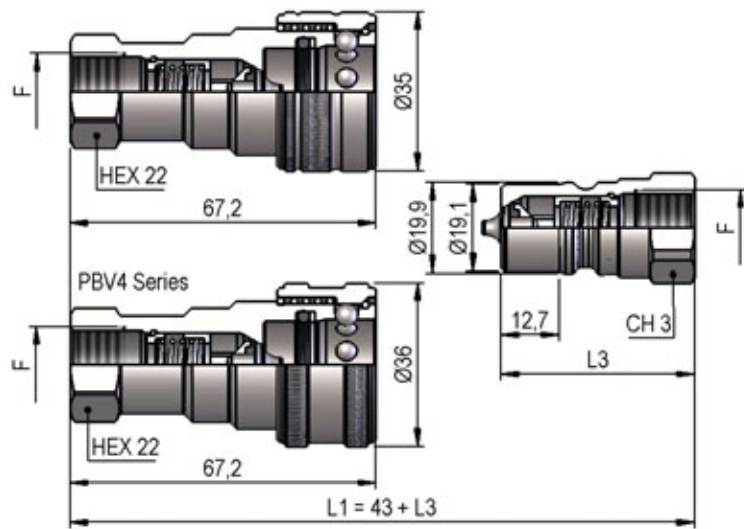

CH3	L3	F	STANDARD	FEMMINA - FEMALE - MUFFE - FEMELLE			MASCHIO - MALE - STECKER - MALE		
				COD. F	Weight (g)	Packaging (pcs.)	COD. M	Weight (g)	Packaging (pcs.)
22	42.5	BSP 3/8"	DIN 3852-2-X	PBV1.1010.002	194	54	PBV1.1010.003	61	200
22	42.5	NPT 3/8"	ANSI B1.20.3	PBV1.1010.012	196	54	PBV1.1010.013	62	200
27	46	3/4"-16 UNF 2B	SAE J 1926-1				PBV1.1019.033	82	150
22	42.5	BSP 3/8"	DIN 3852-2-X	PBV4.1010.002	198	40			
22	42.5	NPT 3/8"	ANSI B1.20.3	PBV4.1010.012	200	40			

## PBV1 DN13 - BG 3 - ISO 12.5

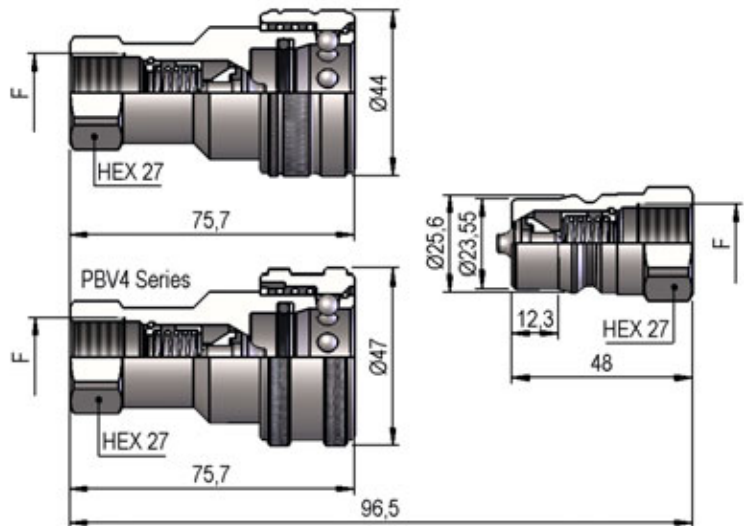

F	STANDARD	FEMMINA - FEMALE - MUFFE - FEMELLE			MASCHIO - MALE - STECKER - MALE		
		COD. F	Weight (g)	Packaging (pcs.)	COD. M	Weight (g)	Packaging (pcs.)
BSP 1/2"	DIN 3852-2-X	PBV1.1313.002	346	45	PBV1.1313.003	112	200
NPT 1/2"	ANSI B1.20.3	PBV1.1313.012	349	45	PBV1.1313.013	115	200
BSP 1/2"	DIN 3852-2-X	PBV4.1313.002	373	30			
NPT 1/2"	ANSI B1.20.3	PBV4.1313.012	376	30			

**PBV1 DN20 - BG 4 - ISO 20**

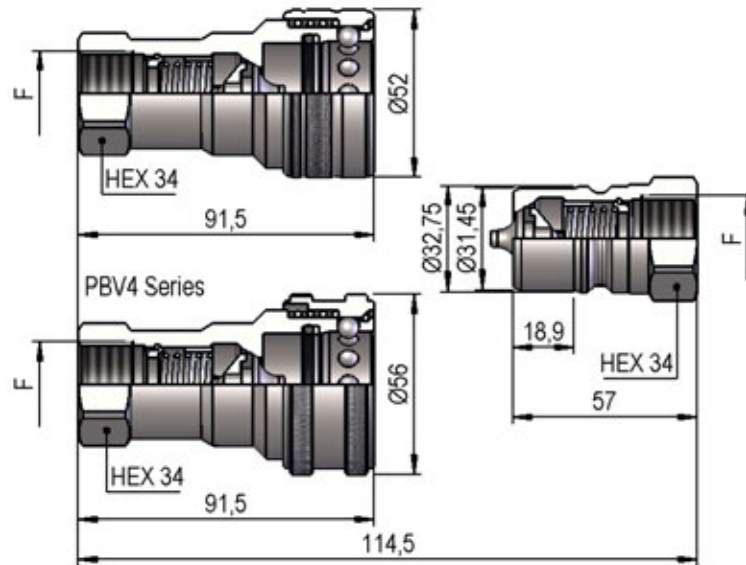

F	STANDARD	FEMMINA - FEMALE - MUFFE - FEMELLE			MASCHIO - MALE - STECKER - MALE		
		COD. F	Weight (g)	Packaging (pcs.)	COD. M	Weight (g)	Packaging (pcs.)
BSP 3/4"	DIN 3852-2-X	PBV1.2019.002	548	25	PBV1.2019.003	202	45
NPT 3/4"	ANSI B1.20.3	PBV1.2019.012	551	25	PBV1.2019.013	207	45
BSP 3/4"	DIN 3852-2-X	PBV4.2019.002	593	20			
NPT 3/4"	ANSI B1.20.3	PBV4.2019.012	596	20			

**PBV1 DN25 - BG 5 - ISO 25**

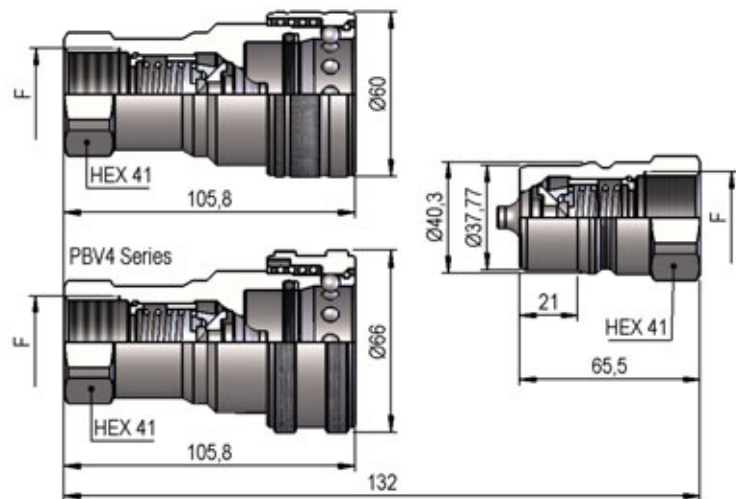

F	STANDARD	FEMMINA - FEMALE - MUFFE - FEMELLE			MASCHIO - MALE - STECKER - MALE		
		COD. F	Weight (g)	Packaging (pcs.)	COD. M	Weight (g)	Packaging (pcs.)
BSP 1"	DIN 3852-2-X	PBV1.2525.002	860	18	PBV1.2525.003	355	30
NPT 1"	ANSI B1.20.3	PBV1.2525.012	870	18	PBV1.2525.013	364	30
BSP 1"	DIN 3852-2-X	PBV4.2525.002	990	15			
NPT 1"	ANSI B1.20.3	PBV4.2525.012	1000	15			

## PBV1 DN39 - BG 7 - ISO 40

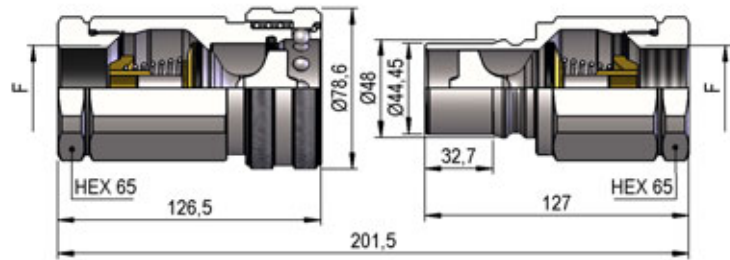

THREADS	F	STANDARD	FEMMINA - FEMALE - MUFFE - FEMELLE			MASCHIO - MALE - STECKER - MALE		
			COD. F	Weight (g)	Packaging (pcs.)	COD. M	Weight (g)	Packaging (pcs.)
IG 1	BSP 1"¼	DIN 3852-2-X	PBV1.3931.002	2132	9	PBV1.3931.003	1340	12
	NPT 1"¼	ANSI B1.20.3	PBV1.3931.012	2147	9	PBV1.3931.013	1355	12
	BSP 1"½	DIN 3852-2-X	PBV1.3939.002	2050	9	PBV1.3939.003	1258	12
	NPT 1"½	ANSI B1.20.3	PBV1.3939.012	2066	9	PBV1.3939.013	1274	12
IG 2	1"5/8-12 UN 2B	SAE J 1926-1	PBV1.3941.032	2139	9	PBV1.3941.033	1347	12

## PBV1 DN50 - BG 8 - ISO 50

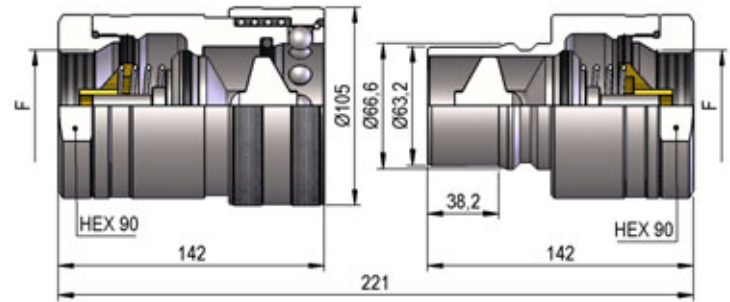

F	STANDARD	FEMMINA - FEMALE - MUFFE - FEMELLE			MASCHIO - MALE - STECKER - MALE		
		COD. F	Weight (g)	Packaging (pcs.)	COD. M	Weight (g)	Packaging (pcs.)
BSP 2"	DIN 3852-2-X	PBV1.5051.002	4900	4	PBV1.5051.003	3100	5
NPT 2"	ANSI B1.20.3	PBV1.5051.012	5000	4	PBV1.5051.013	3200	5

THREADS

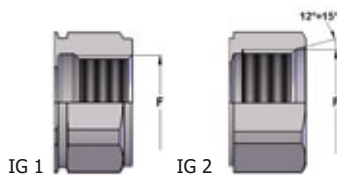

**PLASTIC CAPS**

NOMINAL SIZE			FEMALE DUST PLUG					MALE DUST CAP					COLOR	MATERIAL
DNP	BG	ISO	COD. F	Dimensions			Weight (g)	COD. M	Dimensions			Weight (g)		
				D	L	D1			D	L	D1			
06	1	6.3	SPBV.06032	28	125	21	8	SPBV.06033	28	125	17	8	●	PVC
10	2	10	SPBV.10032	33	135	25	10	SPBV.10033	33	130	20	13	●	PVC
13	3	12.5	SPBV.13032	44	175	32	16	SPBV.13033	40	165	24	20	●	PVC
20	4	20	SPBV.20032	52	190	37	23	SPBV.20033	44	190	31	27	●	PVC
25	5	25	SPBV.25032	61	230	43	30	SPBV.25033	53	230	37	40	●	PVC

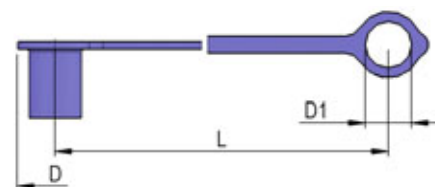
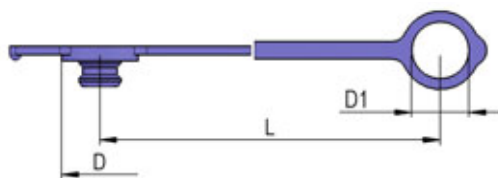

NOMINAL SIZE			FEMALE DUST PLUG					MALE DUST CAP					COLOR	MATERIAL
DNP	BG	ISO	COD. F	Dimensions			Weight (g)	COD. M	Dimensions			Weight (g)		
				D	L	D1			D	L	D1			
06	1	6.3	SPBV.06002	26	240	23	9	SPBV.06003	18	240	23	9	●	PVC
06	1	6.3	SPBV.06042	26	240	23	9	SPBV.06043	18	240	23	9	●	PVC
10	2	10	SPBV.10002	33	235	25	9	SPBV.10003	23	240	24	10	●	PVC
13	3	12.5	SPBV.13002	38	240	29	15	SPBV.13003	29	245	28	13	●	PVC
20	4	20	SPBV.20002	49	240	38	17	SPBV.20003	36	245	38	16	●	PVC
25	5	25	SPBV.25002	60	245	46	24	SPBV.25003	44	235	44	19	●	PVC

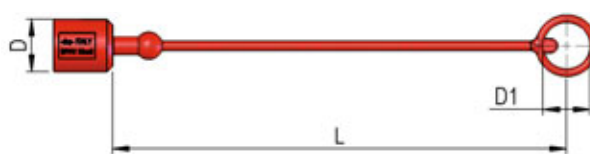
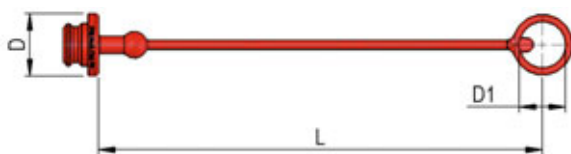

**METAL CAPS**

NOMINAL SIZE			FEMALE DUST PLUG					MALE DUST CAP					MATERIAL
DNP	BG	ISO	COD. F	Dimensions			Weight (g)	COD. M	Dimensions			Weight (g)	
				D	L	D1			D	L	D1		
06	1	6.3	SPBV.06202	22	210	30	15	SPBV.06203	22	245	28	32	Aluminum
06	1	6.3	-	-	-	-	-	SPBV.06303	21	260	19	49	AISI 316
10	2	10	SPBV.10202	22	155	30	18	SPBV.10203	27	155	30	34	Aluminum
13	3	12.5	SPBV.13202	28	305	41	34	SPBV.13203	35	265	41	66	Aluminum
20	4	20	SPBV.20202	35	265	43	49	SPBV.20203	42	250	30	102	Aluminum
25	5	25	SPBV.25202	44	240	41	70	SPBV.25203	48	340	49	126	Aluminum
39	7	40	SPBV.39202	79	225	70.5	139	SPBV.39203	64.5	225	70.5	293	Aluminum
50	8	50	SPBV.50202	105	350	75	265	SPBV.50203	80	350	75	365	Aluminum

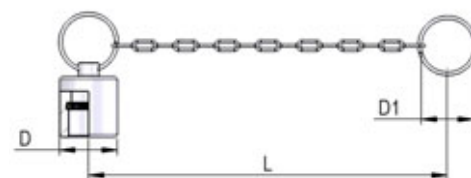
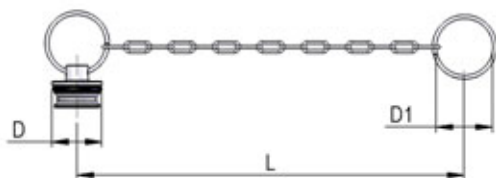

**SPARE PARTS**

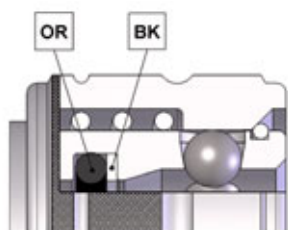

NOMINAL SIZE			FEMALE GASKET	
DNP	BG	ISO	OR (NBR*)	BK (PTFE)
04	0	5	PBV.004.120	PBV.004.130
06	1	6.3	PBV.006.120	PBV.006.130
10	2	10	PDV.010.120	PBV.010.130
13	3	12.5	PBV.013.120	PBV.013.130
20	4	20	PBV.019.120	PBV.019.130
25	5	25	PBV.025.120	PBV.025.130
39	7	40	PBV.039.120	-
50	8	50	PBV.050.120	-

\* AL CODICE DELLA GUARNIZIONE IN NBR AGGIUNGERE 'E' PER EPDM O 'V' PER VITON

\* TO THE NBR GASKET CODE ADD 'E' FOR EPDM OR 'V' FOR VITON

\* ZU DER ARTIKELNR. DER NBR DICHTUNG GEBEN SIE 'E' FUER EPDM ODER 'V' FUER VITON AN

\* AU CODE DU JOINT EN NBR JOINDRE 'E' POUR EPDM OU 'V' POUR VITON